

## Zeiss Ikon Rangefinder Camera



Gebrauchsanweisung  
Instruction Manual  
Instructions d'emploi  
Manual de Instrucciones  
Manuale d'Instruzioni  
Chinese Manual



We make it visible.

## Content

4	Deutsch	DE
28	English	UK
52	Français	FR
76	Español	ES
100	Italiano	IT
124	Chinese	CI

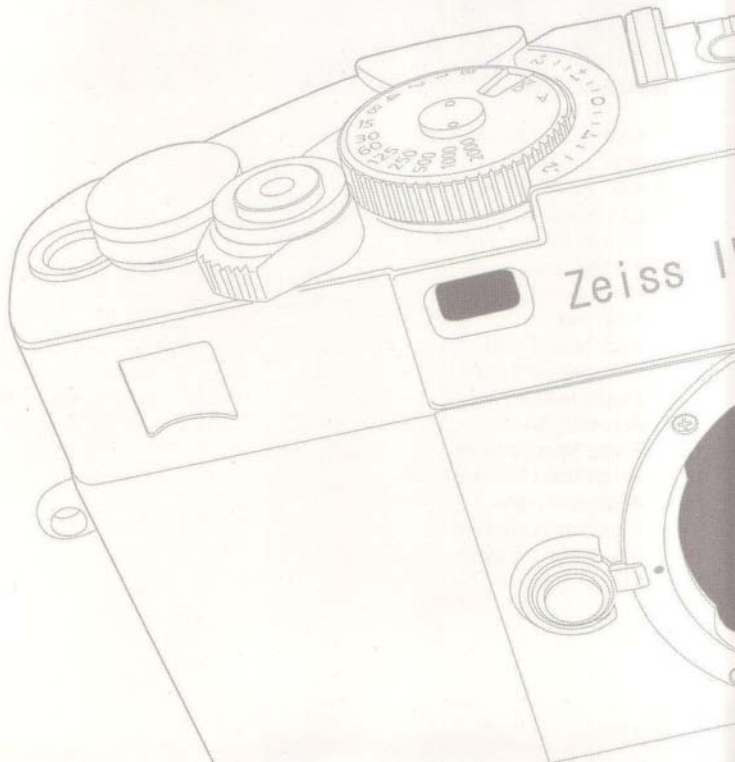

## Description of Parts

- 1 Shutter Speed Index
- 2 Shutter Speed/  
ISO Film Speed Ring
- 3 Film Speed Window
- 4 Shutter Release Button
- 5 Film Advance Lever
- 6 Film Counter
- 7 Main Switch
- 8 Neck Strap Eyelet
- 9 Lens Release Button
- 10 Mount Index
- 11 Accessory Shoe
- 12 Frame Selector Lever
- 13 Rangefinder Window
- 14 Bright-line Frame  
Illumination Window
- 15 Viewfinder Window
- 16 ZM-Lens Mount

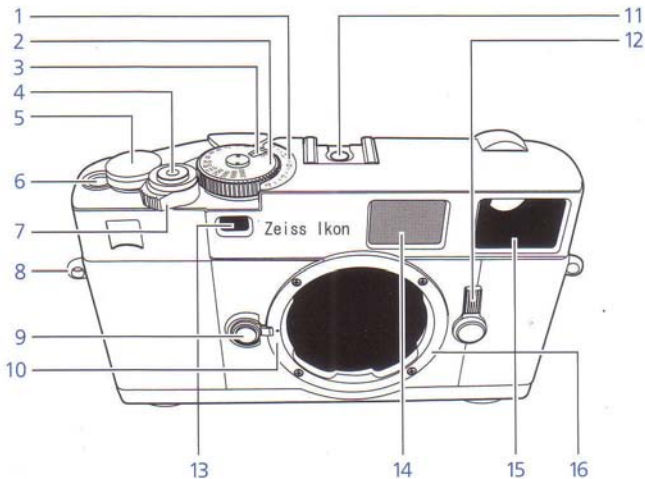



Electronic devices do not belong in the household waste but must be disposed of in an environmentally friendly manner. Take the device to the manufacturer or to your specialist store.

## Proper Care of Your Camera

- Do not use any organic solvent like benzine or alcohol to wipe the camera body.
- Do not leave the camera in a place of high humidity and high temperature. In particular, do not leave the camera in your car.
- Keep the camera away from chemicals (adhesives, cleansing agents etc.). Store the camera in a ventilated place without case or pouch.
- This camera is not waterproof. Do not use the camera in heavy rain, do not expose it to splashing water.
- Shock, impact or other abnormal conditions can cause the camera to malfunction.
- Never attempt to wipe dust or dirt from the lens or the camera finder windows with your fingers. Always use a blower to blow the dust away, or wipe the surface gently with a lens brush or a soft cloth.
- Check the camera and make some trial exposures when you take pictures after a long period of storage, especially before taking important pictures.
- Take care not to expose the camera to sudden changes in temperature which will cause condensation inside the body. Keep the camera in a bag or case for a while to adjust the temperature slowly.
- At temperatures below 0 °C the performance of the battery is reduced. When using the camera in a cold place prepare spare batteries and keep them in a warm place.
- Wipe off the camera after using it in areas subjected to salt spray, dust, sand, chemicals or water splash. Close the camera body with a cap and keep it away from direct sunlight during storage.

## Attaching the Neck Strap

Attach the neck strap to the camera as illustrated below.

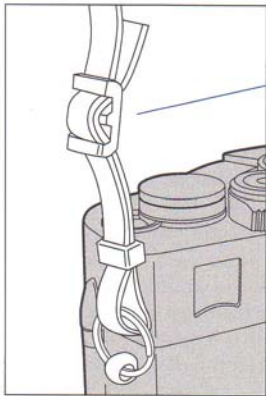
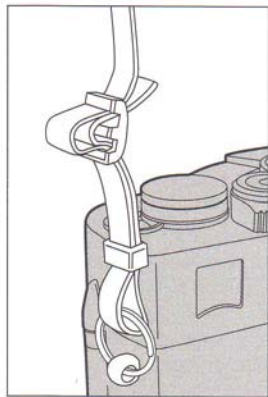

Be sure the protective end of the strap is on the inside.

## Mounting/Removing the Lens

1. To mount the lens, match the blue mark on the camera body with the blue mark on the lens barrel, then insert the lens in the camera body and turn the lens clockwise until it locks with an audible click.

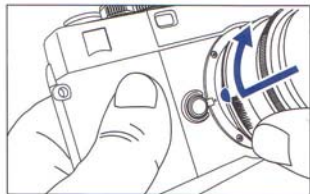

2. To remove the lens from the camera body, press the Lens Release Button (9) and turn the lens all the way counterclockwise, then lift it straight out of the mount.

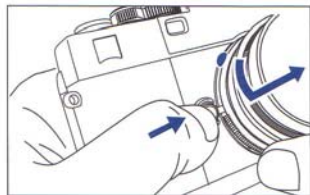

## Inserting Batteries

1. Turn the Battery Chamber Lid (22) counterclockwise using a coin or a suitable screwdriver blade.
2. One CR-1/3 Lithium battery or two LR44 type alkaline or two SR44 type silver batteries may be used to power the camera.
3. Place the batteries so that both positive sides (+) point towards the bottom of the battery chamber.
4. Turn the Battery Chamber Lid (22) clockwise until it is firmly closed.

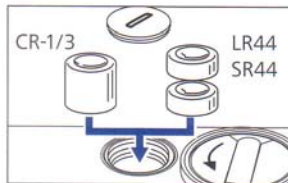
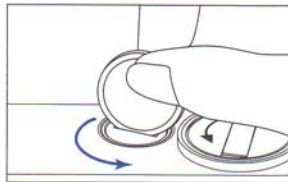



## Battery Check

1. Turn the Main Switch (7) to the ON position.
2. Wind the Film Advance Lever (5).
3. Set the Shutter Speed Ring (2) to any position except the "B" (bulb) position.
4. Press the Shutter Release Button (4) halfway while looking through the Viewfinder Eyepiece (19).
  - If you can see one or two LEDs lit or blinking on the left hand side of the Viewfinder, then the battery condition is satisfactory.
  - If both "2000" and "1" LEDs are blinking slowly, then the batteries are running out of power. Prepare a new set of batteries.
  - If no LED is lit, then the batteries need to be replaced or have been loaded incorrectly.
  - The LEDs will remain on for about 8 sec. after you stop pressing the Shutter Release Button (4).

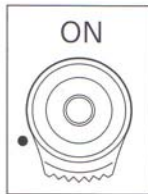

**Note:** In order to avoid battery consumption, turn the Main Switch to the OFF position while the camera is not in use.

## Loading Film

1. To open the Back Door (27), slide the Back Door Lock Button (26) following the direction of the blue arrow, first to the front side of the camera, then upward.  
When the Back Door is opened, the Film Counter (6) will automatically reset to "5".
2. Unfold and lift the Film Rewind Crank (24), then pull the Film Rewind Knob (23).
3. Insert the film cartridge into the Film Cartridge Chamber (25) so that the protruding end of the film cartridge faces downward. Protect the film cartridge against direct sunlight.
4. Rotate the Film Rewind Crank slowly while pushing down the Film Rewind Knob lightly until the film locks on the film rewind fork at the inner side of the Film Rewind Knob (23).
5. Insert the film leader into the grooves of the Film Take-up Spool (32) and place it so that the spool teeth engage the film edge perforations.
6. Check that the film perforations are properly engaged with the teeth of the Film Sprocket Wheel (33) and that the film slides smoothly along the Film Guide Rails (21) while turning the Film Advance Lever (5) lightly in order to advance the film.

**Caution: Do not touch the shutter curtains!**

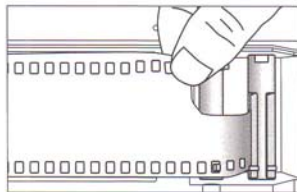
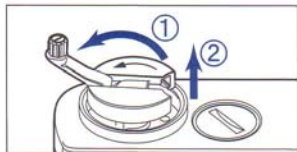
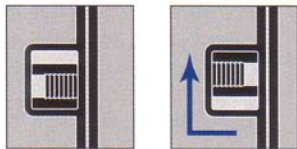

7. Gently close the Back Door (27) and push it until it locks with an audible click.
8. Tense the film by turning the Film Rewind Crank (24) gently in the direction of the arrow until increased resistance is noticeable. Then return the crank to its original rest position.
9. Advance the film a couple of frames by depressing the Shutter Release Button (4) a few times and operating the Film Advance Lever (5) until the Film Counter (6) indicates "1". Make sure that the Film Rewind Knob (23) rotates each time the film is advanced, which will tell you that the film is advancing properly.

**Note: When advancing the film, wind the Film Advance Lever (5) slowly and securely until the film is fully transported to the next frame.**

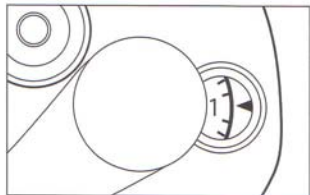
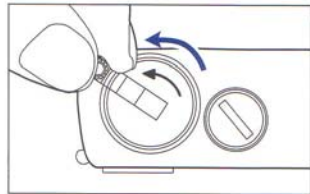
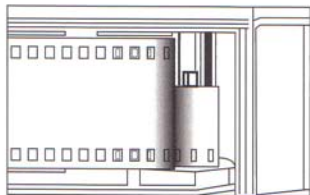

## Film Speed Setting

1. The film speed is indicated on the outside of the film package, on the film cartridge or in the film instructions.
2. To set the film speed: while lifting the Film Speed Ring (2), turn it until the arrow indicator on the inner ring points to the corresponding film speed (ASA / ISO) value which can be seen through the Film Speed Window (3).

**Caution: Make sure to set film speed exactly at a notch position, not in between, otherwise proper shutter speeds will not be shown in the Viewfinder (19).**

Through the Film Confirmation Window (29), you can check the type of the film, the quantity you can shoot, and the ISO speed of the film.

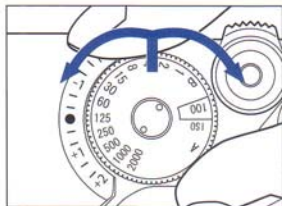

## Exposure Setting

### Aperture Priority Mode (auto exposure mode "AE")

In Aperture Priority (AE) mode, the camera will automatically select the proper shutter speed based on the lens aperture value and the brightness of the subject.

You may select the lens aperture value with consideration of the film speed, the required depth-of-field, the brightness of the subject, motion of the subject ...

Recommended aperture value with ISO 100/21° film under typical situations as shown in the list.

(Shutter speed corresponds from 1/2000 to 8 sec.)

1. Turn the Main Switch (7) to the ON position
2. Set the Shutter Speed Ring to align the "A" mark to the Shutter Speed Index (1).
3. Turn the aperture ring on the lens to the desired aperture value.
4. Advance the film and press the Shutter Release Button (4) halfway, while looking through the Viewfinder (19).
  - In the finder, the LED display will indicate the measured shutter speed.
  - If the "2000" LED blinks fast, this means out of range due to over exposure. Turn the aperture ring on the lens to a higher setting.

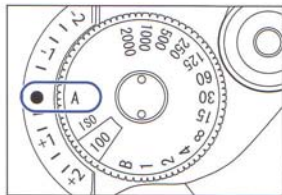

Condition	Aperture (F value)
At night, for handheld shooting	full speed
When you want shallow depth-of-field	full speed
Indoors in normal conditions	F2 – F4
Outdoors on a cloudy day	F4 – F8
Outdoors on a fine day	F8 – F11
Seaside in midsummer	F11 – up
Mountain area with snow	F11 – up

- If the "1" LED lits, the shutter will be released at the speed of 1 sec. to 8 sec.
- If the LED of "1" blinks fast, the image in the camera is too dark for reliable measurement. Turn the aperture ring on the lens to a lower setting.
- The LED will remain on for about 8 sec. after you stop pressing the Shutter Release Button (4). If the LED goes off while composing your shot, then press the Shutter Release Button again (halfway) to reactivate the metering indicator.
- The LED display is switched off as long as the film is not advanced.

5. Press the Shutter Release Button (4) gently to release the shutter.

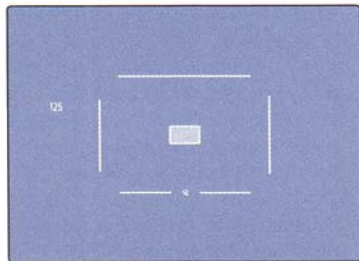

Example: Shutter will be released at 1/125 sec.

## Exposure Compensation

Exposure metering by measurement of subject brightness is based on the assumption of a subject with average reflectance. When the nature of the subject deviates considerably from this normal situation, compensation of the measured exposure becomes necessary. For example: when large parts of the subject are very bright, a (+) compensation is required; when large parts of the subject are dominated by dark tones, a (-) compensation is required for a correctly exposed image. Especially when using positive slide film the technically correct exposure is not necessarily the best exposure according to the taste of the photographer. Therefore, this camera is equipped with an exposure compensation mode.

With help of the exposure compensation mode you can use a different exposure value than the one that aperture priority has determined automatically.

You can change the value to either brighter ((+) compensation) or darker ((-) compensation).

The amount you can compensate for is +/-2 steps, by 1/3 step increments. Set the "A" indicator on the Shutter Speed Ring (2) to the desired value of compensation.

When the exposure compensation mode is active, the indicator LED of the compensated shutter speed will blink slowly.

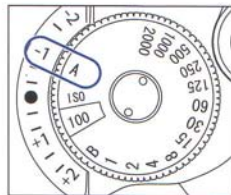

Example: Compensate by -1 step

## AE Lock Function

With all kinds of subjects where bright parts and dark parts are not mixed and homogeneously distributed but clearly separated, the result of exposure metering will depend on the image composition. For example: when a wide angle lens is used, a bright sky will contribute a lot to the metering result when the horizon is in the lower part of the frame. This will probably lead to an underexposure of the main subject. When, however, the camera looks downward and the horizon is close to the upper edge of the frame, the bright sky will contribute less to the exposure metering.

Therefore, the camera is equipped with an AE lock function as a convenient way to make exposure metering independent of image composition.

Use the AE lock function with aperture priority mode or exposure compensation mode. The exposure value will be stored at the moment when the AE Lock Button (20) is released, and also the LED indication in the finder will be locked.

1. Wind up the film and press the Shutter Release Button (4) halfway and check the LED indicator in the finder.
2. You may as well press and hold the AE Lock Button (20) to switch on the metering and the exposure display in the finder.

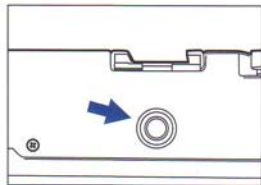



3. Direct the camera to a part of the subject with average brightness. Keep in mind that the metering sensitivity is highest in the center of the frame. Exclude bright light sources or large bright parts of the subject from this area. If necessary, go closer to the main subject.
4. Release the AE Lock Button (20) when the LED indicates the desired exposure value.
  - LED that indicates locked value will start blinking slowly.
  - Locked exposure value and its indication in the finder will be kept for about 20 sec. after you take your finger off the AE Lock Button. (Exposure value will be changed depending on the light value while the AE Lock Button is pressed).
5. Create your composition and release the shutter.
  - The locked exposure value will be kept for about 20 sec. after shutter release, and you can shoot with the same exposure value within 20 sec.
  - When you change the exposure compensation value while AE is locked, the exposure value will be adjusted on the basis of the compensation value.
  - If you turn the aperture ring of the lens while AE lock is on, the exposure value will be changed.
  - The AE lock mode is automatically switched off after 20 sec. when the shutter was not released. But pressing the Shutter Release Button (4) halfway keeps the AE lock mode on for a long time. This enables a sequence of many shots with a locked exposure value, even if the time between subsequent exposures is longer than 20 sec.

To release AE lock, press the AE Lock Button again.

## Exposure Setting

### Manual Exposure

In the manual exposure mode any desired combination of aperture value and exposure time may be selected, while the metered exposure time is just displayed in the finder.

- Indications on the Shutter Speed Ring (2)
  - “2000” means 1/2000 sec.
  - “1” means 1 sec.
  - “B” means bulb
- With brighter and/or fast moving subjects, it is recommended to use higher shutter speeds.

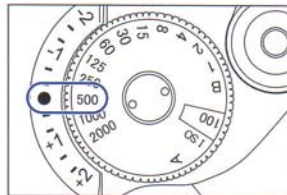

1. Turn the Main Switch (7) to the ON position.
2. Set the Shutter Speed Ring (2) to the desired shutter speed setting.
3. Adjust your focus and press the Shutter Release Button (4) in halfway while looking through the Viewfinder Eyepiece (19).
  - You will see two LED indicators in the finder.
    - One indicates the manually selected shutter speed.
    - A second blinking one indicates the metered shutter speed.

4. Turn either the aperture ring on the lens and/or the Shutter Speed Ring (2) to align the two LEDs until they converge.
- When the blinking LED converges with the other lit indicator, and thus only one LED is lit in the finder, it means you have selected the metered exposure value.
  - You can, of course, set a different aperture and shutter speed on purpose to achieve special effects.
  - Fast blinking of the LED of "2000" when the Shutter Speed Ring is set to 2000 indicates "out of range due to over exposure". Turn the aperture ring on the lens to a higher setting.
  - Fast blinking of the LED of "1" when the Shutter Speed Ring is set to 1 indicates "out of range due to under exposure". Turn the aperture ring on the lens to a lower setting.
  - The LED will remain on for about 8 seconds after you stop pressing the Shutter Release Button (4) or stop turning the Shutter Speed Ring (2).
5. Create your composition and release the shutter.

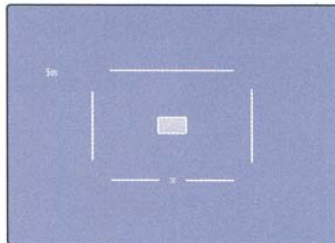
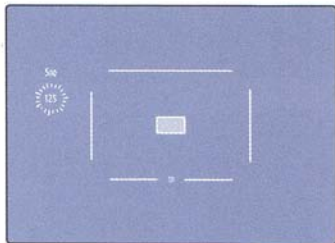

## Selecting the Finder Frame

Your camera changes the finder frame lines automatically depending on the attached lens type. You can also have a preview of other frame lines before deciding for another lens by turning the Frame Selector Lever (12).

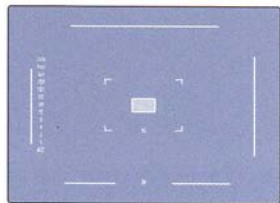

28/85

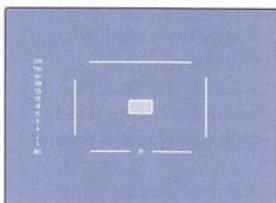

50

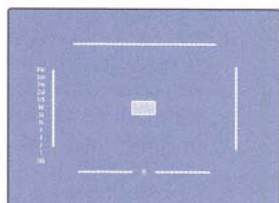

35

## Focusing

### Focusing 1

For accurate focusing with subjects such as a group of people, a "double image" Viewfinder (19) with a central focus zone will ensure that sharp images are easily recorded.

To achieve this, simply turn and adjust the lens until the double image converges to a single one.

### Focusing 2

For accurate focusing of architectural or technical subjects with vertical lines, use the "Split image" focusing option. To achieve this, simply turn and adjust the lens so that the lines join together.

**Note: When focusing, make sure to put your eye in the middle of the Viewfinder.**

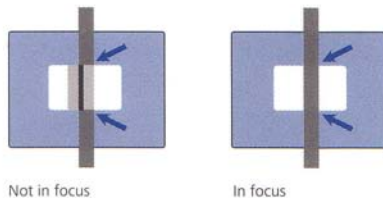
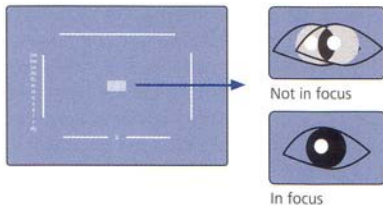

## Holding the Camera

1. Hold the camera in the palm of the left hand so as to turn the lens focusing ring easily with your left hand.
2. Hold the camera body steady and place your right index finger lightly on the Shutter Release Button (4).
3. Press your left elbow lightly against your body and then look through the Viewfinder Eyepiece (19) to steady the camera against your face. Then relax your right arm holding the camera.

**Note: With slower shutter speed, it is recommended to use a tripod and/or cable release to avoid blurring.**



## Rewinding the Film

1. When the roll of film ends, the advance lever will no longer advance smoothly. Check the Film Counter (6) display. If the Film Counter shows that all the frames of the loaded film have been exposed, then the film needs to be rewound.
2. Press the Film Rewind Button (31) on the bottom of the camera.
3. Unfold the Film Rewind Crank (24) and turn it in the direction of the arrow.
4. When the winding tension eases, the film is completely wound into the cartridge and it is ready to be removed.
5. Open the Back Door (27), pull out the Film Rewind Knob (23) and remove the film cartridge.
6. Take care to protect the film cartridge against direct sunlight while you remove it.

**Note:** If the film reaches the end of the roll during film advance, the Film Advance Lever (5) will lock. Rewind the entire roll, then complete the movement of the Film Advance Lever after removing the cartridge.

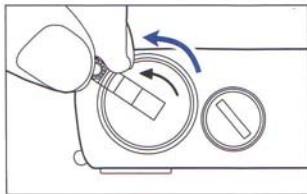
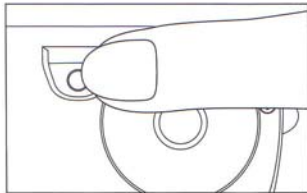

## "B" (Bulb) setting

1. With the Shutter Speed Ring (2) set at "B" position, the shutter will remain open for as long as the Shutter Release Button (4) is held down.
2. This setting is useful when a longer exposure than one second is required, such as in photography at night.
3. Be sure to use a tripod and/or cable release when using long shutter times to avoid camera movement.

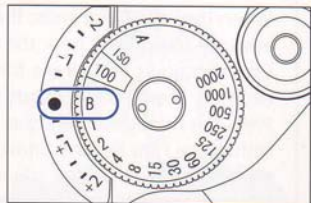



## Flash Photography

1. Simply slide the flash unit into the Accessory Shoe (11).  
With grip (bracket) type flash, connect it to the Synchro Contact (17) by cable.
2. Set the Shutter Speed Ring (2) at 1/125 sec. or slower.  
Flash can be synchronized with shutter speeds slower than 1/125 sec., but be careful to avoid camera or subject movement.
3. Set a suitable aperture value according to the guide number of your flash unit and the distance to the subject. Follow the instruction given in the manual of your flash unit.
4. Make sure that the ready lamp on the flash unit is lit and release the shutter.

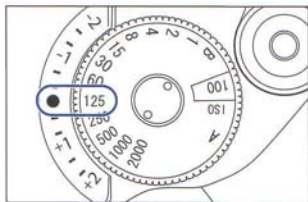

## Diopter Lens

Diopter lenses in 6 types (-3, -2, -1, +1, +2, +3) are available as optional accessories to compensate for individual visual defects.

Attaching a diopter lens

- Turn the rubberized Diopter Correction Lens (18) counterclockwise to detach it.
- Screw the selected Diopter Correction Lens in clockwise.

**Note:** Ask your dealer for details.

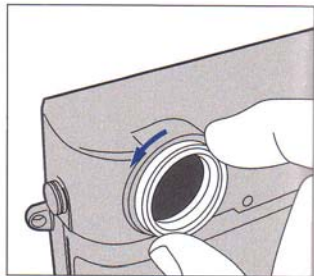

## Specifications

**Camera type:** Compact rangefinder system camera with focal plane shutter and TTL light metering system

**Film format:** 24 x 36 mm on 35 mm film

**Lenses:** Carl Zeiss T\* ZM-mount lenses with focal length 15 mm to 85 mm, can also use nearly all other lens types with M-mount and M39 screw mount with adapter

**Viewfinder:** 0.74x magnification, bright range- and viewfinder with bright line frames activated by lens type in use, displayed frames 28/85 mm, 35 mm, 50 mm; separate frameselector lever for manual frame selection independent of mounted lens, automatic parallax compensation, diopter correction eyepieces -3 to +3 diopters, standard setting -0.5 diopter

**Large base rangefinder:** Coincident-image rangefinder patch in the center of the viewfinder image, measurement base 75 mm (effective 55.5 mm), coupled object distance range: 0.7 m -  $\infty$

**Exposure metering:** TTL center-weighted metering at working aperture, metering range at ISO 100 and f/2: EV 0 - EV 19 (f/2 - 4 sec., f/16 - 1/2000 sec.)

**Film speed range:** ISO 25-3200 manually in 1/3 f-stop increments

**Exposure modes:** AE with aperture priority or manual, AE lock option for a sequence of exposures, exposure compensation +/-2 f-stops in 1/3 steps set at shutter speed dial

**Viewfinder display:** LED symbols for selected shutter speed along left side of frame, warnings for out of range shutter speeds and low battery

**Shutter and shutter speed:** Vertical-travel metal focal-plane shutter, with electronically controlled speeds (1/12 f-stop resolution) from 8-1/2000 sec. in automatic mode; 1-1/2000 sec. in 1-stop increments in manual mode; B

**Flash synch:** Synchronization at 1/125 sec. and longer shutter speeds

**Film transport:** Rapid-wind manual advance lever, with ratcheted partial advance

**Camera body:** One piece aluminum base structure, external magnesium covers, tripod thread 1/4 inch in base

**Batteries:** One CR 1/3 Lithium or two 1.5 V cells type LR44 or SR44

**Dimensions/Weight:** 138 x 77.5 x 32 mm (5.4" x 3.1" x 1.3"), 460 g (16 oz)

Specifications subject to change without prior notice in the course of further development.

- 17 Synchro Contact
- 18 Diopter Correction Lens
- 19 Viewfinder Eyepiece
- 20 AE Lock Button
- 21 Film Guide Rails
- 22 Battery Chamber
- 23 Film Rewind Knob
- 24 Film Rewind Crank
- 25 Film Cartridge Chamber
- 26 Back Door Lock/Unlock
- 27 Back Door
- 28 Film Pressure Plate
- 29 Film Confirmation Window
- 30 Tripod Socket
- 31 Film Rewind Button
- 32 Film Take-up Spool
- 33 Film Sprocket Wheel

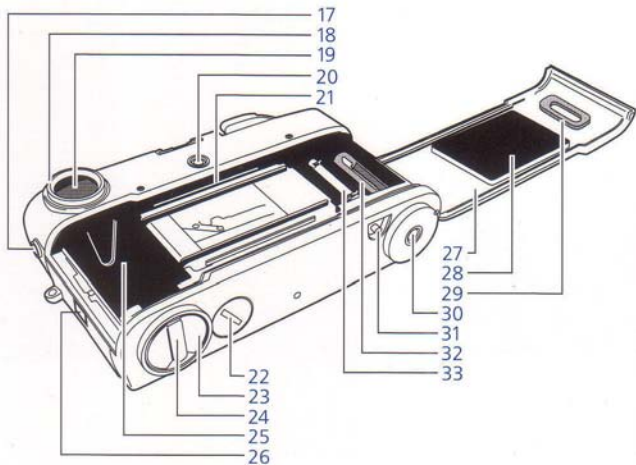

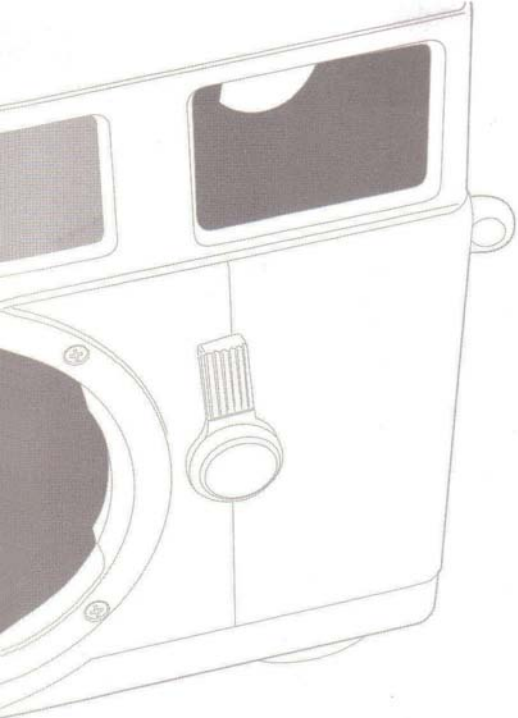



Carl Zeiss AG  
Camera Lens Division  
73446 Oberkochen  
[www.zeiss.de/photo](http://www.zeiss.de/photo)  
[www.zeissikon.com](http://www.zeissikon.com)